



# USING THE FIERY ADVANCED CONTROLLER INTERFACE KIT

## Copyright © 2001 Electronics For Imaging All rights reserved.

This publication is protected by copyright, and all rights are reserved. No part of it may be reproduced or transmitted in any form or by any means for any purpose without express prior written consent from Electronics For Imaging except as expressly permitted herein. Information in this document is subject to change without notice and does not represent a commitment on the part of Electronics For Imaging.

The software described in this publication is furnished under license and may only be used or copied in accordance with the terms of such license.

Patents: 5,867,179; 5,835,788; 5,666,436; 5,553,200; 5,543,940; 5,537,516; 5,517,334; 5,506,946; 5,424,754; 5,343,311; 5,212,546; 4,941,038; 4,837,722; 4,500,919, D406,117

**Printed in the United States of America on recycled paper.**

### Restricted Rights Legends

For defense agencies: Restricted Rights Legend. Use, reproduction, or disclosure is subject to restrictions set forth in subparagraph (c)(1)(ii) of the Rights in Technical Data and Computer Software clause at 252.227.7013.

For civilian agencies: Restricted Rights Legend. Use, reproduction, or disclosure is subject to restrictions set forth in subparagraph (a) through (d) of the commercial Computer Software Restricted Rights clause at 52.227-19 and the limitations set forth in Electronics For Imaging's standard commercial agreement for this software. Unpublished rights reserved under the copyright laws of the United States.

### FCC Information

WARNING: FCC Regulations state that any unauthorized changes or modifications to this equipment not expressly approved by the manufacturer could void the user's authority to operate this equipment.

### Industry Canada Class A Notice

This digital apparatus does not exceed the Class A limits for radio noise emissions from digital apparatus as set out in the interference-causing equipment standard entitled, "Digital Apparatus" ICES-003 from Industry Canada.

### Avis de Conformation Classe A de l'Industrie Canada

Le présent appareil numérique n'émet pas de bruits radioélectriques dépassant les limites applicables aux appareils numériques de la Classe A prescrites dans la norme sur le matériel brouilleur, "Appareils Numériques" NMB-003 édictée par l'Industrie Canada.

### Class B Declaration of Conformity

This equipment has been tested and found to comply with the limits for a class B digital device, pursuant to Part 15 of the FCC rules. These limits are designed to provide reasonable protection against harmful interference in a residential installation. This equipment generates, uses and can radiate radio frequency energy and if not installed and used in accordance with the instructions, may cause harmful interference to radio communications. However, there is no guarantee that interference will not occur in a particular installation.

If this equipment does cause harmful interference to radio or television reception, which can be determined by turning the equipment off and on, the user is encouraged to try to correct the interference by one or more of the following measures:

Reorient or relocate the receiving antenna.

Increase the separation between the equipment and receiver.

Connect the equipment into an outlet on a circuit different from that to which the receiver is connected.

Consult the dealer or an experienced radio/TV technician for help.

In order to maintain compliance with FCC regulations, shielded cables must be used with this equipment. Operation with non-approved equipment or unshielded cables is likely to result in interference to radio and TV reception. The user is cautioned that changes and modifications made to the equipment without the approval of manufacturer could void the user's authority to operate this equipment.

### Industry Canada Class B Notice

This Class B digital apparatus meets all the requirements of the Canadian Interference-Causing Equipment Regulations.

### Avis de Conformation Classe B de l'Industrie Canada

Cet appareil numérique de la classe B respecte toutes les exigences du Règlement sur le matériel brouilleur du Canada.

### RFI Compliance Notice

This equipment has been tested concerning compliance with the relevant RFI protection requirements both individually and on system level (to simulate normal operation conditions). However, it is possible that these RFI Requirements are not met under certain unfavorable

conditions in other installations. It is the user who is responsible for compliance of his particular installation.

Dieses Gerat wurde einzeln sowohl als auch in einer Anlage, die einen normalen Anwendungsfall nachbildet, auf die Einhaltung der Funk-entstoerbestimmungen gepueft. Es ist jedoch moeglich, dass die Funk-entstoerbestimmungen unter unguenstigen Umstaenden bei anderen Geratekombinationen nicht eingehalten werden. Fuer die Einhaltung der Funk-entstoerbestimmungen seigner gesamten Anlage, in der dieses Gerat betrieben wird, ist der Betreiber verantwortlich.

Compliance with applicable regulations depends on the use of shielded cables. It is the user who is responsible for procuring the appropriate cables.

Einhaltung mit betreffenden Bestimmungen kommt darauf an, dass geschirmte Ausfuhrungen gebraucht werden. Fuer die beschaffung richtiger Ausfuhrungen ist der Betreiber verantwortlich.

### Proprietary Rights

You acknowledge that the Software, Coded Font Programs, Typefaces, Trademarks and accompanying documentation are proprietary to Electronics For Imaging and its suppliers and that title and other intellectual property rights therein remain with Electronics For Imaging and its suppliers. Except as stated above, this Agreement does not grant you any right to patents, copyrights, trade secrets, trademarks (whether registered or unregistered), or any other rights, franchises or licenses in respect of the Software, Coded Font Programs, Typefaces, Trademarks or accompanying documentation. You may not adapt or use any trademark or trade name which is likely to be similar to or confusing with that of Electronics For Imaging or any of its suppliers or take any other action which impairs or reduces the trademark rights of Electronics For Imaging or its suppliers. The trademarks may only be used to identify printed output produced by the Coded Font Programs. At the reasonable request of Electronics For Imaging, you must supply samples of any Typeface identified with a trademark.

### Confidentiality

You agree to hold the Software and Coded Font Programs in confidence, disclosing the Software and Coded Font Programs only to authorized users having a need to use the Software and Coded Font Programs as permitted by this Agreement and to take all reasonable precautions to prevent disclosure to other parties.

### Remedies

Unauthorized use, copying or disclosure of the Software, Coded Font Programs, Typefaces, Trademarks or accompanying documentation will result in automatic termination of this license and will make available to Electronics For Imaging other legal remedies.

### Limited Warranty And Disclaimer

Electronics For Imaging warrants that, for a period of ninety (90) days from the date of delivery to you, the Software under normal use will perform without significant errors that make it unusable. Electronics For Imaging's entire liability and your exclusive remedy under this warranty (which is subject to you returning Print Server to Electronics For Imaging or an authorized dealer) will be, at Electronics For Imaging's option, to use reasonable commercial efforts to attempt to correct or work around errors, to replace the Software with functionally equivalent software, or to refund the purchase price and terminate this Agreement. Some states do not allow limitations on duration of implied warranty, so the above limitation may not apply to you.

Except for the above express limited warranty, Electronics For Imaging makes and you receive no warranties or conditions on the Products, express, implied, or statutory, and Electronics For Imaging specifically disclaims any implied warranty or condition of merchantability or fitness for a particular purpose.

For warranty service, please contact your authorized service/support center.

EXCEPT FOR THE ABOVE EXPRESS LIMITED WARRANTY, ELECTRONICS FOR IMAGING MAKES AND YOU RECEIVE NO WARRANTIES OR CONDITIONS ON THE SOFTWARE OR CODED FONT PROGRAMS, EXPRESS, IMPLIED, STATUTORY, OR IN ANY OTHER PROVISION OF THIS AGREEMENT OR COMMUNICATION WITH YOU, AND ELECTRONICS FOR IMAGING SPECIFICALLY DISCLAIMS ANY IMPLIED WARRANTY OR CONDITION OF MERCHANTABILITY OR FITNESS FOR A PARTICULAR PURPOSE. Electronics For Imaging does not warrant that the operation of the software will be uninterrupted or error free or that the Software will meet your specific requirements.

**Limitation Of Liability**

IN NO EVENT WILL ELECTRONICS FOR IMAGING OR ITS SUPPLIERS BE LIABLE FOR ANY DAMAGES, INCLUDING LOSS OF DATA, LOST PROFITS, COST OF COVER OR OTHER SPECIAL, INCIDENTAL, CONSEQUENTIAL OR INDIRECT DAMAGES ARISING FROM THE USE OF THE SOFTWARE, CODED FONT PROGRAMS OR ACCOMPANYING DOCUMENTATION, HOWEVER CAUSED AND ON ANY THEORY OF LIABILITY. THIS LIMITATION WILL APPLY EVEN IF ELECTRONICS FOR IMAGING OR ANY AUTHORIZED DEALER HAS BEEN ADVISED OF THE POSSIBILITY OF SUCH DAMAGE. YOU ACKNOWLEDGE THAT THE PRICE OF THE UNIT REFLECTS THIS ALLOCATION OF RISK. BECAUSE SOME STATES/JURISDICTIONS DO NOT ALLOW THE EXCLUSION OR LIMITATION OF LIABILITY FOR CONSEQUENTIAL OR INCIDENTAL DAMAGES, THE ABOVE LIMITATION MAY NOT APPLY TO YOU.

**Export Controls**

You agree that you will not export or re-export the Software or Coded Font Programs in any form without the appropriate United States and foreign government licenses. Your failure to comply with this provision is a material breach of this Agreement.

**Government Use**

Use, duplication or disclosure of the Software by the United States Government is subject to restrictions as set forth in subdivision (c) (1) (ii) of the Rights in Technical Data and Computer Software clause at DFARS 252.227-7013 or in subparagraphs (c) (1) and (2) of the Commercial Computer Software—Restricted Right Clause at 48 CFR 52.227-19, as applicable.

**Third Party Beneficiary**

You are hereby notified that Adobe Systems Incorporated, a California corporation located at 345 Park Avenue, San Jose, CA 95110-2704 ("Adobe") is a third-party beneficiary to this Agreement to the extent that this Agreement contains provisions which relate to your use of the Fonts, the Coded Font Programs, the Typefaces and the Trademarks licensed hereby. Such provisions are made expressly for the benefit of Adobe and are enforceable by Adobe in addition to Electronics For Imaging.

**General**

This Agreement will be governed by the laws of the State of California.

This Agreement is the entire agreement held between us and supersedes any other communications or advertising with respect to the Software, Coded Font Programs and accompanying documentation.

If any provision of this Agreement is held invalid, the remainder of this Agreement shall continue in full force and effect.

If you have any questions concerning this Agreement, please write to Electronics For Imaging, Attn: Licensing Dept. or see Electronics For Imaging's web site at [www.efi.com](http://www.efi.com).

Electronics For Imaging  
303 Velocity Way  
Foster City, CA 94404

## Introduction

This document describes how to install the Fiery Advanced Controller Interface (FACI) option for use with the Print Server. The FACI option allows a monitor, keyboard, and mouse to be connected to the Print Server. In order to connect a monitor, keyboard, and mouse to the Print Server, you will need to install the AGP video board and enable the FACI option using the dongle and CD provided in this kit.

**NOTE:** The illustrations in this document may include components that are not installed in the Print Server you are servicing.

Along with this document, this kit includes:

- AGP video board
- Monitor, keyboard, and mouse
- Dongle (can only be used for one installation)
- Restore/Update Server Software CD

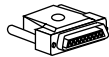

In order to use this kit, you need to:

- Insert the CD into the CD-ROM drive on the Print Server
- Shut down the system and power off the Print Server
- Open the Print Server
- Install the AGP video board
- Reassemble the Print Server
- Install the dongle on the parallel port at the back of the Print Server
- Connect the monitor, keyboard, and mouse to the back of the Print Server
- Power on the Print Server and initialize the FACI option
- Remove the CD from the Print Server's CD-ROM drive
- Power off the Print Server
- Remove the dongle from the back of the Print Server
- Power on the Print Server
- Install Command WorkStation software on the Print Server from the User Software CD.

## Procedures

Before shutting down the Print Server, make sure to install the Restore/Update Server Software CD in the Print Server's CD-ROM drive. Always use the procedure below when shutting down the Print Server.

---

### TO INSTALL THE RESTORE/UPDATE SERVER SOFTWARE CD AND SHUT DOWN THE PRINT SERVER



Always verify that the Print Server is not in use before you power off or restart it. Make sure that the system is not ripping or printing a job.

1. Make sure the Info screen reads Idle.  
When Printing or Ripping appears on the Control Panel, the system is currently processing. Idle appears in the Info screen when the system is finished processing the job.
2. Install the Restore/Update Server Software CD in the Print Server's CD-ROM drive.
3. At the Idle screen, press the menu button once to display the Functions menu.
4. Select Shut Down from the Functions menu.
5. At the next screen, select Shut Down System.  
The message It is now safe to power off the system.... is displayed.
6. Power off the system using the power switch on the back panel (press 0).
7. Disconnect all cables from the back panel of the Print Server.  
Always obtain permission from the network administrator before you take the Print Server off the network.

## Using the fiery Advanced Controller Interface Kit

---

### TO OPEN THE PRINT SERVER

1. Make sure you have powered off the Print Server and removed all the cables from the back panel.
2. Remove the two screws that secure the side panel to the chassis.
3. Lift off the side panel.

Press on the front edge of the side panel as you slide the panel off the chassis.

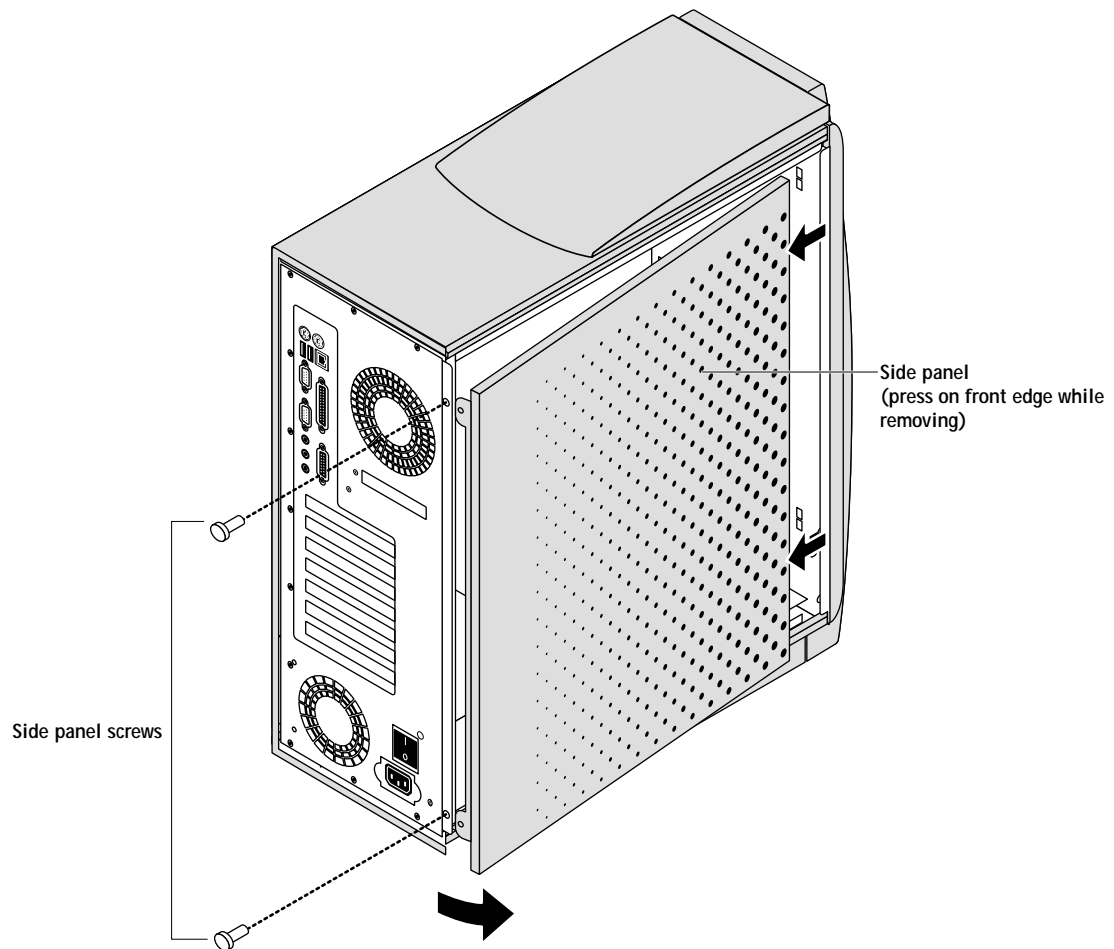

The inside of the Print Server is now accessible. Make sure to wear an ESD wrist strap while handling internal parts.

## Procedures

### TO INSTALL THE AGP VIDEO BOARD

1. Unpack the AGP video board.
2. Remove the cover plate from slot 1 on the back panel of the Print Server.  
Set aside the cover plate mounting screw for use later in this procedure.
3. Position the AGP video board so that the component side of the board faces down toward the power supply.

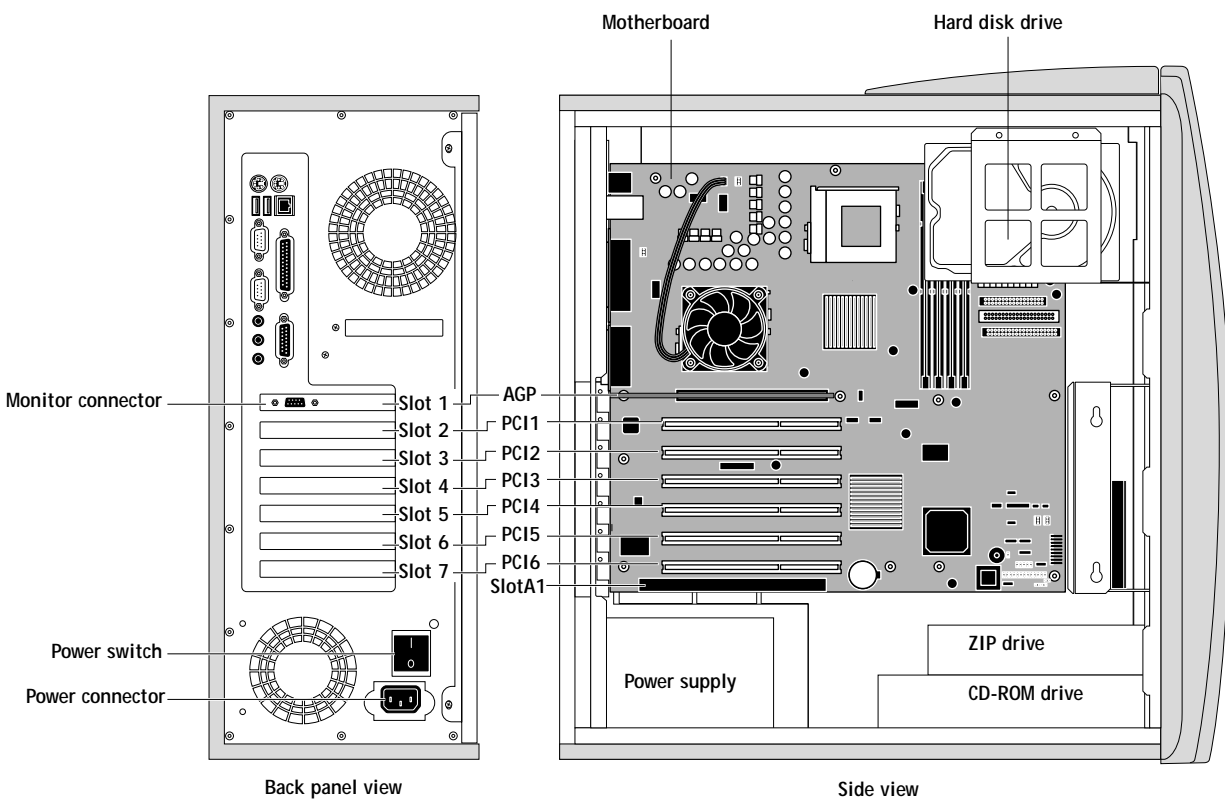

**NOTE:** The Print Server you are servicing may include an additional CPU and other boards not shown above.

4. Insert the edge connector of the AGP video board into the AGP connector on the motherboard (slot 1).  
The board's edge connector is keyed to fit only one way when properly oriented.
5. Use the mounting screw removed earlier to secure the AGP video board in slot 1 on the back panel.

---

TO REASSEMBLE THE PRINT SERVER

1. Reseat all boards, cables, connectors, and other parts loosened or removed during service.
2. Slide the side panel into the grooves along the edges of the chassis.

Be careful not to damage any ribbon cables; fold the ribbon cables inside the chassis before replacing the side panel. Press on the front edge of the side panel during installation in order to compress the EMI gaskets around the edges of the chassis.

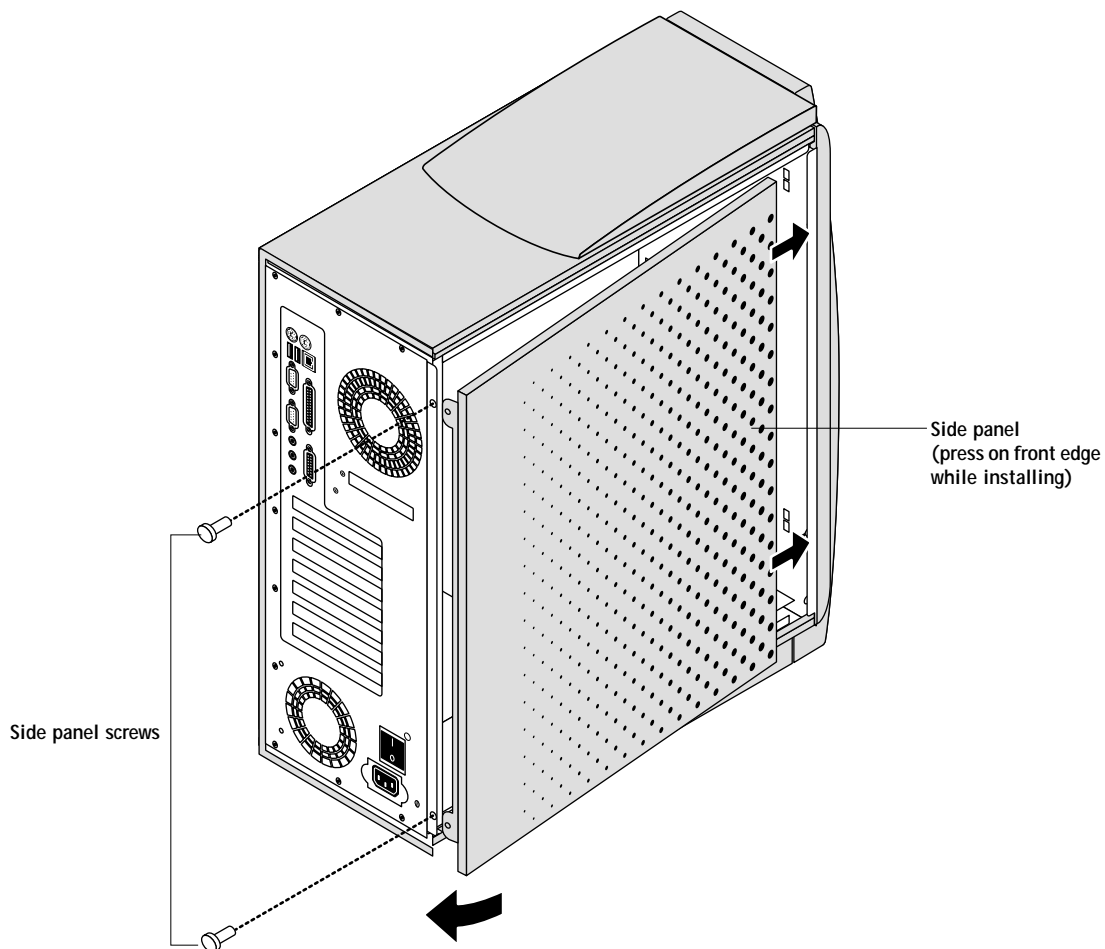

3. Replace the two screws that secure the side panel to the chassis.  
**NOTE:** Do not leave the Print Server side panel off after servicing. An airflow channel is created by the side panel and the fans. Leaving the Print Server open could reduce the operational life expectancy of internal Print Server components.
4. Connect any cables removed during service to the back of the Print Server.



## Procedures

### TO ENABLE THE FACI OPTION

**NOTE:** This procedure assumes that the Print Server is powered off and the Restore/Update Server Software CD is installed in the Print Server's CD-ROM drive.

The dongle and the Restore/Update Server Software CD are used together to enable the FACI option on the Print Server.

1. Connect the dongle to the parallel port as shown in the following illustration.

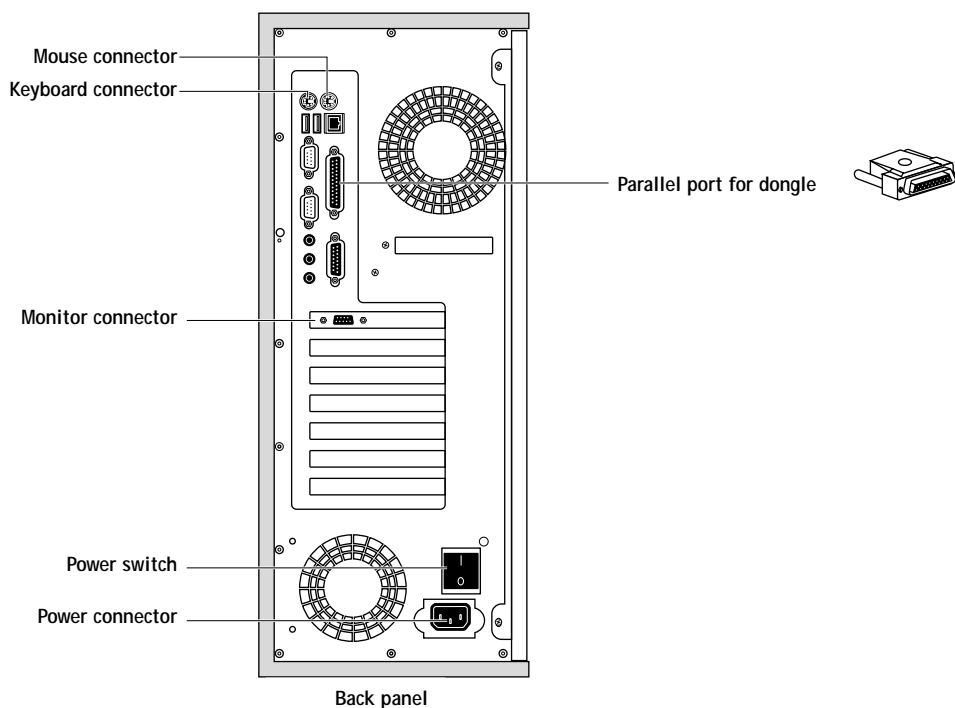

2. Unpack the monitor, keyboard, and mouse.
3. Connect the monitor, keyboard, and mouse to the back panel of the Print Server.  
If the monitor cable is not already connected to the back of the monitor, connect it according to the instructions provided in the monitor documentation.
4. Connect the monitor power cable to the back of the monitor (some monitors may already have this cable connected).
5. Connect the other end of the monitor power cable to a wall outlet.
6. Make sure all the cables are connected to the back panel.
7. Power on the monitor and the Print Server.  
Allow the system to perform startup diagnostics and boot.

## Using the fiery Advanced Controller Interface Kit

- When the Restore/Update menu appears, scroll to display "Update system", select OK, then wait.

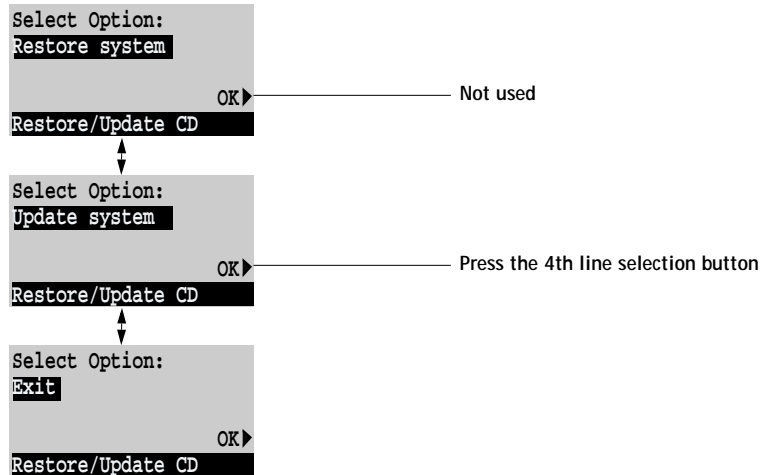

- At the message "Update complete" select OK.
- Scroll to display "Exit" and select OK.
- At the message "Remove CD and recycle power", remove the CD and power off.
- Remove the dongle and mark it used.
- Power on the system using the power switch on the back panel and allow the system to reach Idle.
- When the system is idle, you can install Command WorkStation software from the User Software CD. (For installation information, see *Getting Started*.)

### Error messages

The following error messages may appear on the Control Panel LCD if a required system update is not done.

Wrong/Missing . . . dongle—the system was not upgraded. Install the correct dongle and repeat the system update procedure.

Used Dongle—the dongle has already been used to upgrade a system and cannot be used again.



## USING THE TOKEN RING KIT

## Copyright © 2001 Electronics For Imaging All rights reserved.

This publication is protected by copyright, and all rights are reserved. No part of it may be reproduced or transmitted in any form or by any means for any purpose without express prior written consent from Electronics For Imaging except as expressly permitted herein. Information in this document is subject to change without notice and does not represent a commitment on the part of Electronics For Imaging.

The software described in this publication is furnished under license and may only be used or copied in accordance with the terms of such license.

Patents: 5,867,179; 5,835,788; 5,666,436; 5,553,200; 5,543,940; 5,537,516; 5,517,334; 5,506,946; 5,424,754; 5,343,311; 5,212,546; 4,941,038; 4,837,722; 4,500,919, D406,117

Printed in the United States of America on recycled paper.

### Restricted Rights Legends

For defense agencies: Restricted Rights Legend. Use, reproduction, or disclosure is subject to restrictions set forth in subparagraph (c)(1)(ii) of the Rights in Technical Data and Computer Software clause at 252.227.7013.

For civilian agencies: Restricted Rights Legend. Use, reproduction, or disclosure is subject to restrictions set forth in subparagraph (a) through (d) of the commercial Computer Software Restricted Rights clause at 52.227-19 and the limitations set forth in Electronics For Imaging's standard commercial agreement for this software. Unpublished rights reserved under the copyright laws of the United States.

### FCC Information

WARNING: FCC Regulations state that any unauthorized changes or modifications to this equipment not expressly approved by the manufacturer could void the user's authority to operate this equipment.

### Class A Compliance

This equipment has been tested and found to comply with the limits for a Class A digital device, pursuant to Part 15 of the FCC Rules. These limits are designed to provide reasonable protection against harmful interference when the equipment is operated in a commercial environment. This equipment generates, and uses, and can radiate radio frequency energy and, if not installed and used in accordance with the instruction manual, may cause harmful interference to radio communications. Operation of this equipment in a residential area is likely to cause interference in which case the user will be required to correct the interference at his own expense.

### Industry Canada Class A Notice

This digital apparatus does not exceed the Class A limits for radio noise emissions from digital apparatus as set out in the interference-causing equipment standard entitled, "Digital Apparatus" ICES-003 from Industry Canada.

### Avis de Conformation Classe A de l'Industrie Canada

Le présent appareil numérique n'émet pas de bruits radioélectriques dépassant les limites applicables aux appareils numériques de la Classe A prescrites dans la norme sur le matériel brouilleur, "Appareils Numériques" NMB-003 édictée par l'Industrie Canada.

### Class B Declaration of Conformity

This equipment has been tested and found to comply with the limits for a class B digital device, pursuant to Part 15 of the FCC rules. These limits are designed to provide reasonable protection against harmful interference in a residential installation. This equipment generates, uses and can radiate radio frequency energy and if not installed and used in accordance with the instructions, may cause harmful interference to radio communications. However, there is no guarantee that interference will not occur in a particular installation.

If this equipment does cause harmful interference to radio or television reception, which can be determined by turning the equipment off and on, the user is encouraged to try to correct the interference by one or more of the following measures:

Reorient or relocate the receiving antenna.

Increase the separation between the equipment and receiver.

Connect the equipment into an outlet on a circuit different from that to which the receiver is connected.

Consult the dealer or an experienced radio/TV technician for help.

In order to maintain compliance with FCC regulations, shielded cables must be used with this equipment. Operation with non-approved equipment or unshielded cables is likely to result in interference to radio and TV reception. The user is cautioned that changes and modifications made to the equipment without the approval of manufacturer could void the user's authority to operate this equipment.

### Industry Canada Class B Notice

This Class B digital apparatus meets all the requirements of the Canadian Interference-Causing Equipment Regulations.

### Avis de Conformation Classe B de l'Industrie Canada

Cet appareil numérique de la classe B respecte toutes les exigences du Règlement sur le matériel brouilleur du Canada.

### RFI Compliance Notice

This equipment has been tested concerning compliance with the relevant RFI protection requirements both individually and on system level (to simulate normal operation conditions). However, it is possible that these RFI Requirements are not met under certain unfavorable conditions in other installations. It is the user who is responsible for compliance of his particular installation.

Dieses Gerat wurde einzeln sowohl als auch in einer Anlage, die einen normalen Anwendungsfall nachbildet, auf die Einhaltung der Funk-entstoerbestimmungen gepueft. Es ist jedoch moeglich, dass die Funk-entstoerbestimmungen unter unguenstigen Umstaenden bei anderen Geratekombinationen nicht eingehalten werden. Fuer die Einhaltung der Funk-entstoerbestimmungen seigner gesamten Anlage, in der dieses Gerat betrieben wird, ist der Betreiber verantwortlich.

Compliance with applicable regulations depends on the use of shielded cables. It is the user who is responsible for procuring the appropriate cables.

Einhaltung mit betreffenden Bestimmungen kommt darauf an, dass geschirmte Ausfuehrungen gebraucht werden. Fuer die beschaffung richtiger Ausfuehrungen ist der Betreiber verantwortlich.

### Proprietary Rights

You acknowledge that the Software, Coded Font Programs, Typefaces, Trademarks and accompanying documentation are proprietary to Electronics For Imaging and its suppliers and that title and other intellectual property rights therein remain with Electronics For Imaging and its suppliers. Except as stated above, this Agreement does not grant you any right to patents, copyrights, trade secrets, trademarks (whether registered or unregistered), or any other rights, franchises or licenses in respect of the Software, Coded Font Programs, Typefaces, Trademarks or accompanying documentation. You may not adapt or use any trademark or trade name which is likely to be similar to or confusing with that of Electronics For Imaging or any of its suppliers or take any other action which impairs or reduces the trademark rights of Electronics For Imaging or its suppliers. The trademarks may only be used to identify printed output produced by the Coded Font Programs. At the reasonable request of Electronics For Imaging, you must supply samples of any Typeface identified with a trademark.

### Confidentiality

You agree to hold the Software and Coded Font Programs in confidence, disclosing the Software and Coded Font Programs only to authorized users having a need to use the Software and Coded Font Programs as permitted by this Agreement and to take all reasonable precautions to prevent disclosure to other parties.

### Remedies

Unauthorized use, copying or disclosure of the Software, Coded Font Programs, Typefaces, Trademarks or accompanying documentation will result in automatic termination of this license and will make available to Electronics For Imaging other legal remedies.

### Limited Warranty And Disclaimer

Electronics For Imaging warrants that, for a period of ninety (90) days from the date of delivery to you, the Software under normal use will perform without significant errors that make it unusable. Electronics For Imaging's entire liability and your exclusive remedy under this warranty (which is subject to you returning Print Server to Electronics For Imaging or an authorized dealer) will be, at Electronics For Imaging's option, to use reasonable commercial efforts to attempt to correct or work around errors, to replace the Software with functionally equivalent software, or to refund the purchase price and terminate this Agreement. Some states do not allow limitations on duration of implied warranty, so the above limitation may not apply to you.

Except for the above express limited warranty, Electronics For Imaging makes and you receive no warranties or conditions on the Products, express, implied, or statutory, and Electronics For Imaging specifically disclaims any implied warranty or condition of merchantability or fitness for a particular purpose.

For warranty service, please contact your authorized service/support center.

EXCEPT FOR THE ABOVE EXPRESS LIMITED WARRANTY, ELECTRONICS FOR IMAGING MAKES AND YOU RECEIVE NO WARRANTIES OR CONDITIONS ON THE SOFTWARE OR CODED FONT PROGRAMS, EXPRESS, IMPLIED, STATUTORY, OR IN ANY OTHER PROVISION OF THIS AGREEMENT OR COMMUNICATION WITH YOU, AND ELECTRONICS FOR IMAGING SPECIFICALLY DISCLAIMS ANY IMPLIED WARRANTY OR CONDITION OF MERCHANTABILITY OR FITNESS FOR A PARTICULAR PURPOSE. Electronics For Imaging does not warrant that the operation of the software will be uninterrupted or error free or that the Software will meet your specific requirements.

**Limitation Of Liability**

IN NO EVENT WILL ELECTRONICS FOR IMAGING OR ITS SUPPLIERS BE LIABLE FOR ANY DAMAGES, INCLUDING LOSS OF DATA, LOST PROFITS, COST OF COVER OR OTHER SPECIAL, INCIDENTAL, CONSEQUENTIAL OR INDIRECT DAMAGES ARISING FROM THE USE OF THE SOFTWARE, CODED FONT PROGRAMS OR ACCOMPANYING DOCUMENTATION, HOWEVER CAUSED AND ON ANY THEORY OF LIABILITY. THIS LIMITATION WILL APPLY EVEN IF ELECTRONICS FOR IMAGING OR ANY AUTHORIZED DEALER HAS BEEN ADVISED OF THE POSSIBILITY OF SUCH DAMAGE. YOU ACKNOWLEDGE THAT THE PRICE OF THE UNIT REFLECTS THIS ALLOCATION OF RISK. BECAUSE SOME STATES/JURISDICTIONS DO NOT ALLOW THE EXCLUSION OR LIMITATION OF LIABILITY FOR CONSEQUENTIAL OR INCIDENTAL DAMAGES, THE ABOVE LIMITATION MAY NOT APPLY TO YOU.

**Export Controls**

You agree that you will not export or re-export the Software or Coded Font Programs in any form without the appropriate United States and foreign government licenses. Your failure to comply with this provision is a material breach of this Agreement.

**Government Use**

Use, duplication or disclosure of the Software by the United States Government is subject to restrictions as set forth in subdivision (c) (1) (ii) of the Rights in Technical Data and Computer Software clause at DFARS 252.227-7013 or in subparagraphs (c) (1) and (2) of the Commercial Computer Software—Restricted Right Clause at 48 CFR 52.227-19, as applicable.

**Third Party Beneficiary**

You are hereby notified that Adobe Systems Incorporated, a California corporation located at 345 Park Avenue, San Jose, CA 95110-2704 ("Adobe") is a third-party beneficiary to this Agreement to the extent that this Agreement contains provisions which relate to your use of the Fonts, the Coded Font Programs, the Typefaces and the Trademarks licensed hereby. Such provisions are made expressly for the benefit of Adobe and are enforceable by Adobe in addition to Electronics For Imaging.

**General**

This Agreement will be governed by the laws of the State of California.

This Agreement is the entire agreement held between us and supersedes any other communications or advertising with respect to the Software, Coded Font Programs and accompanying documentation.

If any provision of this Agreement is held invalid, the remainder of this Agreement shall continue in full force and effect.

If you have any questions concerning this Agreement, please write to Electronics For Imaging, Attn: Licensing Dept. or see Electronics For Imaging's web site at [www.efi.com](http://www.efi.com).

Electronics For Imaging  
303 Velocity Way  
Foster City, CA 94404

## Introduction

This document describes how to install the Token Ring board in a Print Server in order to connect it to a Token Ring network.

**NOTE:** The illustrations in this document may include components that are not installed in the Print Server you are servicing.

The Token Ring kit includes this document and the Token Ring board. To install the Token Ring board, you need to:

- Power off and open the Print Server
- Install the Token Ring board
- Reassemble the Print Server

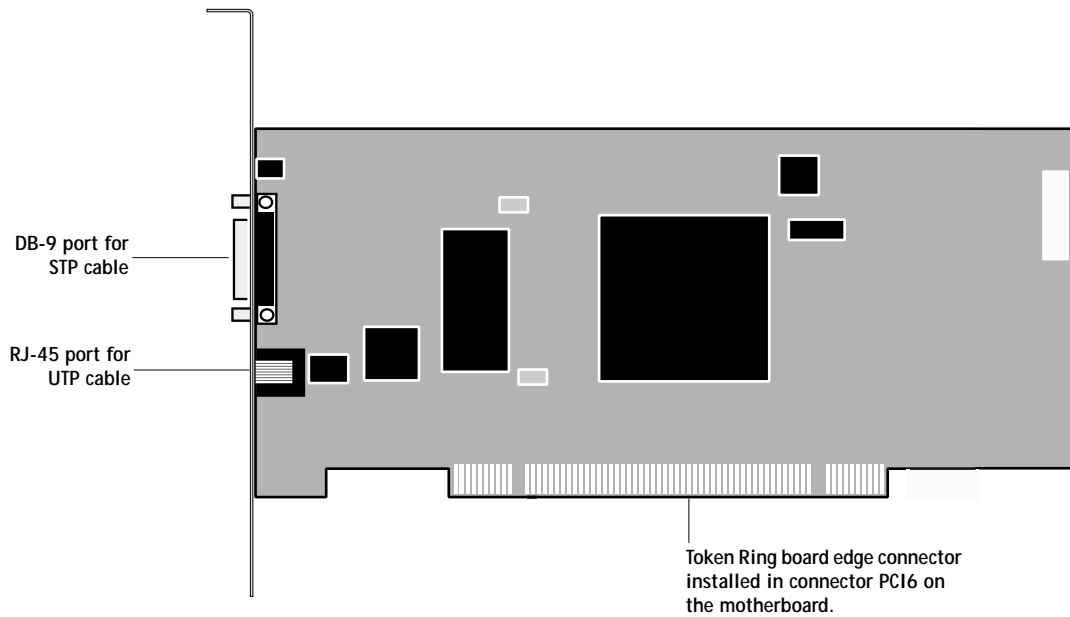

Token Ring Board

## Procedures

The Token Ring board is installed in connector PCI6 on the motherboard.

Always use the procedures below when shutting down and opening the Print Server for service.

---

### TO SHUT DOWN THE PRINT SERVER



Always verify that the Print Server is not being used before you power off the Print Server.

1. **Make sure that the Print Server Info screen reads Idle.**  
When Printing or Ripping appears on the Control Panel the Print Server is currently processing a job. Idle appears in the Info screen when the Print Server is finished processing the job.
2. **At the Idle screen, press the menu button once to display the Functions menu.**
3. **Select Shut Down from the Functions menu.**
4. **At the next screen, select Shut Down System.**  
The message It is now safe to power off the system... is displayed.
5. **Power off the Print Server using the power switch on the back panel (press 0).**
6. **Disconnect all cables from the back panel of the Print Server.**  
Always obtain permission from the network administrator before you take the Print Server off the network.

## Procedures

---

### TO OPEN THE PRINT SERVER

1. Make sure you have powered off the Print Server and removed all the cables from the back panel.
2. Remove the two screws that secure the side panel to the chassis.
3. Lift off the side panel.

Press on the front edge of the side panel as you slide the panel off the chassis.

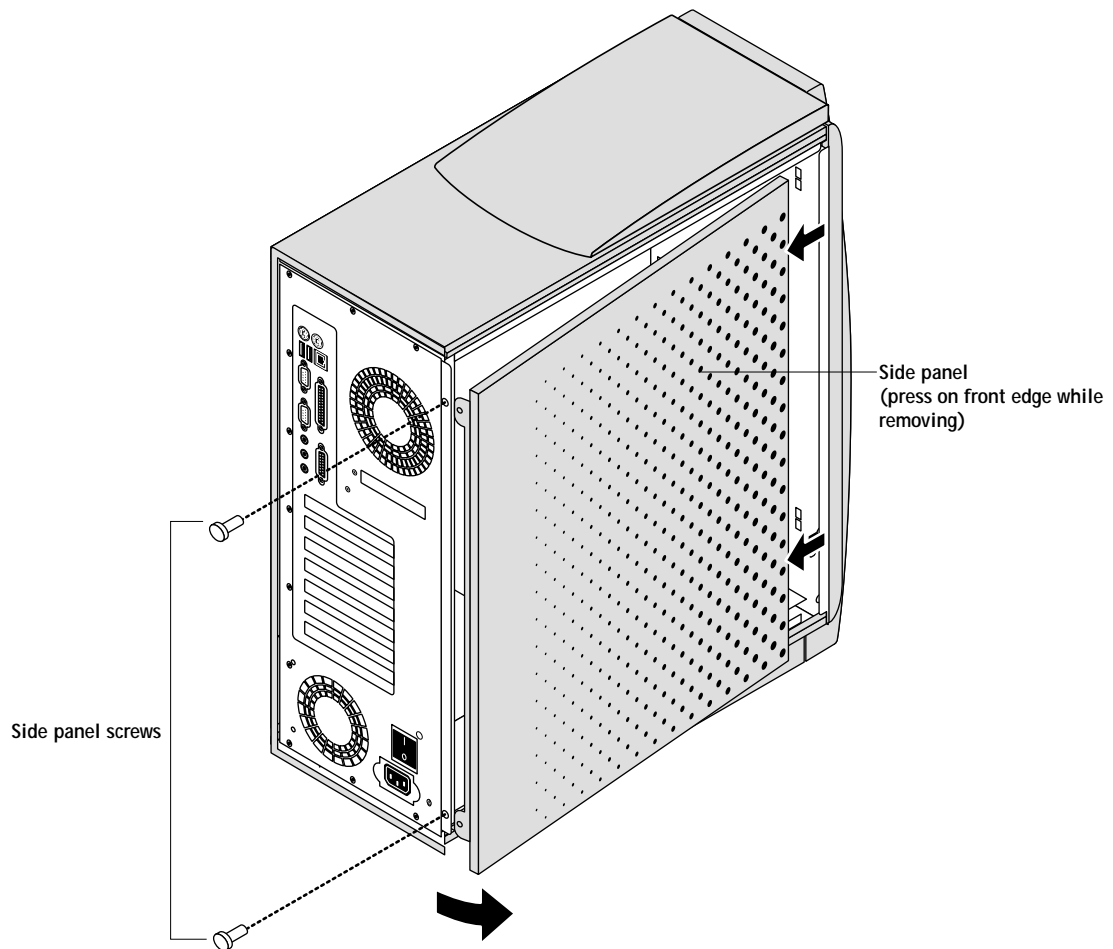

The inside of the Print Server is now accessible. Make sure to wear an ESD wrist strap while handling internal parts.



## Procedures

### TO INSTALL THE TOKEN RING BOARD

1. Unpack the Token Ring board.
2. Remove the cover plate from slot 7 on the back panel of the Print Server.  
Set aside the cover plate mounting screw for use later in this procedure.
3. Position the Token Ring board so that the component side of the board faces down toward the power supply.
4. Insert the edge connector of the Token Ring board into motherboard connector PCI16.  
The edge connector on the Token Ring board is keyed to fit the PCI connector only one way.
5. Use the mounting screw removed earlier to secure the Token Ring board in slot 7 on the back panel.

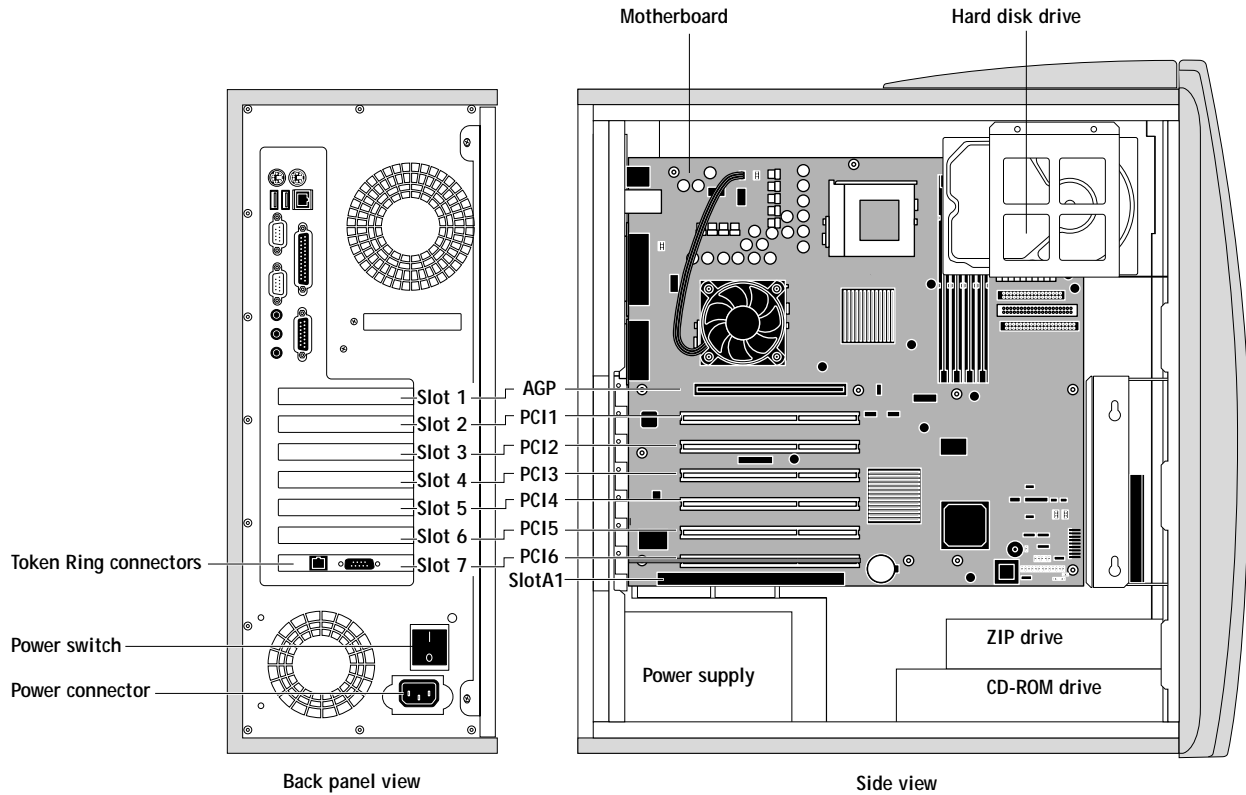

**NOTE:** The Print Server you are servicing may include an additional CPU and other boards not shown above.

---

TO REASSEMBLE THE PRINT SERVER

1. Reseat all boards, cables, connectors, and other parts loosened or removed during service.
2. Slide the side panel into the grooves along the edges of the chassis.

Be careful not to damage any ribbon cables; fold the ribbon cables inside the chassis before replacing the side panel. Press on the front edge of the side panel during installation in order to compress the EMI gaskets around the edges of the chassis.

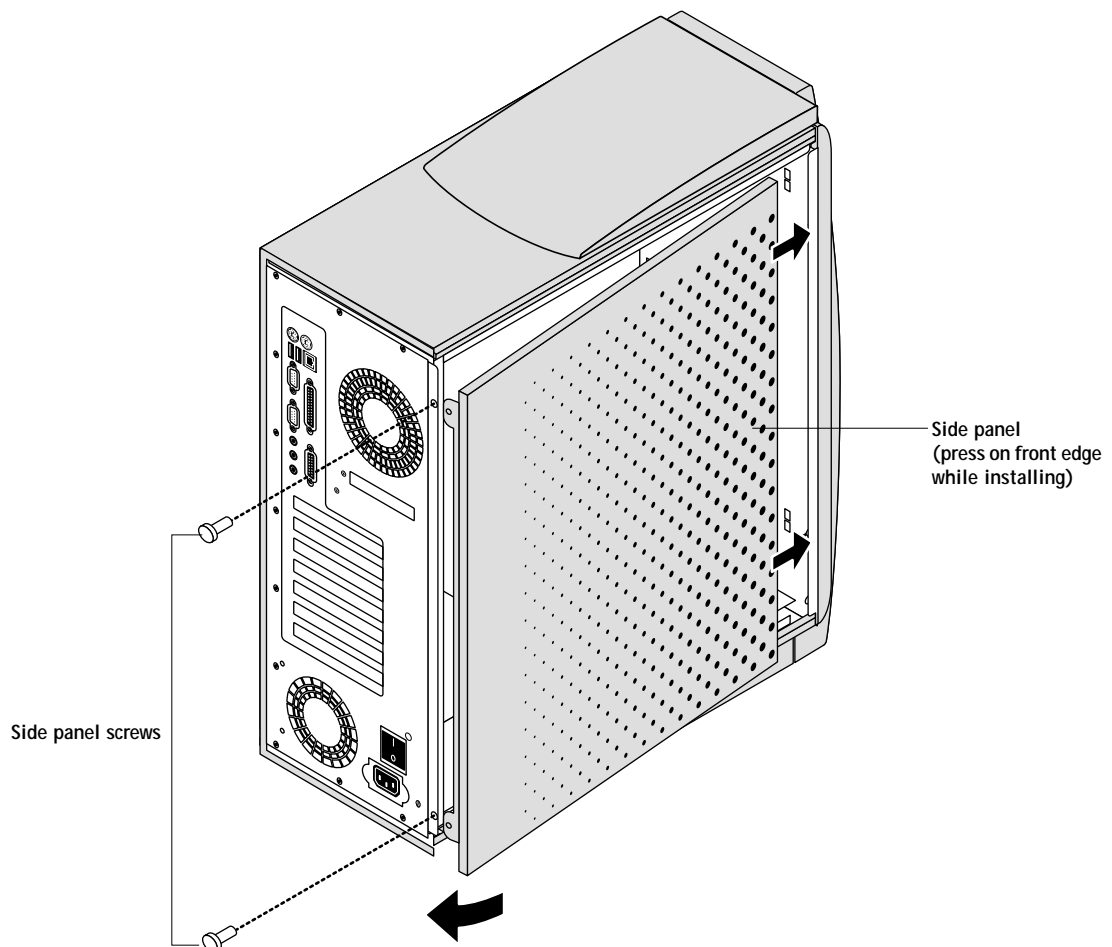

3. Replace the two screws that secure the side panel to the chassis.

**NOTE:** Do not leave the Print Server side panel off after servicing. An airflow channel is created by the side panel and the fans. Leaving the Print Server open could reduce the operational life expectancy of internal Print Server components.

4. Connect any cables removed during service to the back of the Print Server.

## Procedures

5. Connect the Token Ring network cable to the appropriate connector in slot 7.  
The Print Server is configured to automatically detect whether the customer has connected a shielded twisted pair (STP) cable with a DB-9 connector, or an unshielded twisted pair (UTP) cable with an RJ-type connector; therefore, make sure that the Token Ring network cable is connected prior to configuring the Setup options.
6. Power on the system and check startup as described in the *Installation and Service Guide*.
7. Reconfigure Setup.  
The system administrator at the customer site will need to configure specific Setup options in order to connect the Print Server to a Token Ring network. For detailed instructions on configuring Setup options, refer to the *Configuration Guide*.



## USING THE DUAL CPU KIT

## Copyright © 2001 Electronics For Imaging. All rights reserved.

This publication is protected by copyright, and all rights are reserved. No part of it may be reproduced or transmitted in any form or by any means for any purpose without express prior written consent from Electronics For Imaging except as expressly permitted herein. Information in this document is subject to change without notice and does not represent a commitment on the part of Electronics For Imaging.

The software described in this publication is furnished under license and may only be used or copied in accordance with the terms of such license.

Patents: 5,867,179; 5,835,788; 5,666,436; 5,553,200; 5,543,940; 5,537,516; 5,517,334; 5,506,946; 5,424,754; 5,343,311; 5,212,546; 4,941,038; 4,837,722; 4,500,919, D406,117

**Printed in the United States of America on recycled paper.**

### Restricted Rights Legends

For defense agencies: Restricted Rights Legend. Use, reproduction, or disclosure is subject to restrictions set forth in subparagraph (c)(1)(ii) of the Rights in Technical Data and Computer Software clause at 252.227.7013.

For civilian agencies: Restricted Rights Legend. Use, reproduction, or disclosure is subject to restrictions set forth in subparagraph (a) through (d) of the commercial Computer Software Restricted Rights clause at 52.227-19 and the limitations set forth in Electronics For Imaging's standard commercial agreement for this software. Unpublished rights reserved under the copyright laws of the United States.

### FCC Information

WARNING: FCC Regulations state that any unauthorized changes or modifications to this equipment not expressly approved by the manufacturer could void the user's authority to operate this equipment.

### Industry Canada Class A Notice

This digital apparatus does not exceed the Class A limits for radio noise emissions from digital apparatus as set out in the interference-causing equipment standard entitled, "Digital Apparatus" ICES-003 from Industry Canada.

### Avis de Conformation Classe A de l'Industrie Canada

Le présent appareil numérique n'émet pas de bruits radioélectriques dépassant les limites applicables aux appareils numériques de la Classe A prescrites dans la norme sur le matériel brouilleur, "Appareils Numériques" NMB-003 édictée par l'Industrie Canada.

### Class B Declaration of Conformity

This equipment has been tested and found to comply with the limits for a class B digital device, pursuant to Part 15 of the FCC rules. These limits are designed to provide reasonable protection against harmful interference in a residential installation. This equipment generates, uses and can radiate radio frequency energy and if not installed and used in accordance with the instructions, may cause harmful interference to radio communications. However, there is no guarantee that interference will not occur in a particular installation.

If this equipment does cause harmful interference to radio or television reception, which can be determined by turning the equipment off and on, the user is encouraged to try to correct the interference by one or more of the following measures:

Reorient or relocate the receiving antenna.

Increase the separation between the equipment and receiver.

Connect the equipment into an outlet on a circuit different from that to which the receiver is connected.

Consult the dealer or an experienced radio/TV technician for help.

In order to maintain compliance with FCC regulations, shielded cables must be used with this equipment. Operation with non-approved equipment or unshielded cables is likely to result in interference to radio and TV reception. The user is cautioned that changes and modifications made to the equipment without the approval of manufacturer could void the user's authority to operate this equipment.

### Industry Canada Class B Notice

This Class B digital apparatus meets all the requirements of the Canadian Interference-Causing Equipment Regulations.

### Avis de Conformation Classe B de l'Industrie Canada

Cet appareil numérique de la classe B respecte toutes les exigences du Règlement sur le matériel brouilleur du Canada.

### RFI Compliance Notice

This equipment has been tested concerning compliance with the relevant RFI protection requirements both individually and on system level (to simulate normal operation conditions). However, it is possible that these RFI Requirements are not met under certain unfavorable

conditions in other installations. It is the user who is responsible for compliance of his particular installation.

Dieses Gerat wurde einzeln sowohl als auch in einer Anlage, die einen normalen Anwendungsfall nachbildet, auf die Einhaltung der Funk-entstoerbestimmungen gepueft. Es ist jedoch moeglich, dass die Funk-entstoerbestimmungen unter unguenstigen Umstaenden bei anderen Geratekombinationen nicht eingehalten werden. Fuer die Einhaltung der Funk-entstoerbestimmungen seigner gesamten Anlage, in der dieses Gerat betrieben wird, ist der Betreiber verantwortlich.

Compliance with applicable regulations depends on the use of shielded cables. It is the user who is responsible for procuring the appropriate cables.

Einhaltung mit betreffenden Bestimmungen kommt darauf an, dass geschirmte Ausfuehrungen gebraucht werden. Fuer die beschaffung richtiger Ausfuehrungen ist der Betreiber verantwortlich.

### Proprietary Rights

You acknowledge that the Software, Coded Font Programs, Typefaces, Trademarks and accompanying documentation are proprietary to Electronics For Imaging and its suppliers and that title and other intellectual property rights therein remain with Electronics For Imaging and its suppliers. Except as stated above, this Agreement does not grant you any right to patents, copyrights, trade secrets, trademarks (whether registered or unregistered), or any other rights, franchises or licenses in respect of the Software, Coded Font Programs, Typefaces, Trademarks or accompanying documentation. You may not adapt or use any trademark or trade name which is likely to be similar to or confusing with that of Electronics For Imaging or any of its suppliers or take any other action which impairs or reduces the trademark rights of Electronics For Imaging or its suppliers. The trademarks may only be used to identify printed output produced by the Coded Font Programs. At the reasonable request of Electronics For Imaging, you must supply samples of any Typeface identified with a trademark.

### Confidentiality

You agree to hold the Software and Coded Font Programs in confidence, disclosing the Software and Coded Font Programs only to authorized users having a need to use the Software and Coded Font Programs as permitted by this Agreement and to take all reasonable precautions to prevent disclosure to other parties.

### Remedies

Unauthorized use, copying or disclosure of the Software, Coded Font Programs, Typefaces, Trademarks or accompanying documentation will result in automatic termination of this license and will make available to Electronics For Imaging other legal remedies.

### Limited Warranty And Disclaimer

Electronics For Imaging warrants that, for a period of ninety (90) days from the date of delivery to you, the Software under normal use will perform without significant errors that make it unusable. Electronics For Imaging's entire liability and your exclusive remedy under this warranty (which is subject to you returning Print Server to Electronics For Imaging or an authorized dealer) will be, at Electronics For Imaging's option, to use reasonable commercial efforts to attempt to correct or work around errors, to replace the Software with functionally equivalent software, or to refund the purchase price and terminate this Agreement. Some states do not allow limitations on duration of implied warranty, so the above limitation may not apply to you.

Except for the above express limited warranty, Electronics For Imaging makes and you receive no warranties or conditions on the Products, express, implied, or statutory, and Electronics For Imaging specifically disclaims any implied warranty or condition of merchantability or fitness for a particular purpose.

For warranty service, please contact your authorized service/support center.

EXCEPT FOR THE ABOVE EXPRESS LIMITED WARRANTY, ELECTRONICS FOR IMAGING MAKES AND YOU RECEIVE NO WARRANTIES OR CONDITIONS ON THE SOFTWARE OR CODED FONT PROGRAMS, EXPRESS, IMPLIED, STATUTORY, OR IN ANY OTHER PROVISION OF THIS AGREEMENT OR COMMUNICATION WITH YOU, AND ELECTRONICS FOR IMAGING SPECIFICALLY DISCLAIMS ANY IMPLIED WARRANTY OR CONDITION OF MERCHANTABILITY OR FITNESS FOR A PARTICULAR PURPOSE. Electronics For Imaging does not warrant that the operation of the software will be uninterrupted or error free or that the Software will meet your specific requirements.

**Limitation Of Liability**

IN NO EVENT WILL ELECTRONICS FOR IMAGING OR ITS SUPPLIERS BE LIABLE FOR ANY DAMAGES, INCLUDING LOSS OF DATA, LOST PROFITS, COST OF COVER OR OTHER SPECIAL, INCIDENTAL, CONSEQUENTIAL OR INDIRECT DAMAGES ARISING FROM THE USE OF THE SOFTWARE, CODED FONT PROGRAMS OR ACCOMPANYING DOCUMENTATION, HOWEVER CAUSED AND ON ANY THEORY OF LIABILITY. THIS LIMITATION WILL APPLY EVEN IF ELECTRONICS FOR IMAGING OR ANY AUTHORIZED DEALER HAS BEEN ADVISED OF THE POSSIBILITY OF SUCH DAMAGE. YOU ACKNOWLEDGE THAT THE PRICE OF THE UNIT REFLECTS THIS ALLOCATION OF RISK. BECAUSE SOME STATES/JURISDICTIONS DO NOT ALLOW THE EXCLUSION OR LIMITATION OF LIABILITY FOR CONSEQUENTIAL OR INCIDENTAL DAMAGES, THE ABOVE LIMITATION MAY NOT APPLY TO YOU.

**Export Controls**

You agree that you will not export or re-export the Software or Coded Font Programs in any form without the appropriate United States and foreign government licenses. Your failure to comply with this provision is a material breach of this Agreement.

**Government Use**

Use, duplication or disclosure of the Software by the United States Government is subject to restrictions as set forth in subdivision (c) (1) (ii) of the Rights in Technical Data and Computer Software clause at DFARS 252.227-7013 or in subparagraphs (c) (1) and (2) of the Commercial Computer Software—Restricted Right Clause at 48 CFR 52.227-19, as applicable.

**Third Party Beneficiary**

You are hereby notified that Adobe Systems Incorporated, a California corporation located at 345 Park Avenue, San Jose, CA 95110-2704 ("Adobe") is a third-party beneficiary to this Agreement to the extent that this Agreement contains provisions which relate to your use of the Fonts, the Coded Font Programs, the Typefaces and the Trademarks licensed hereby. Such provisions are made expressly for the benefit of Adobe and are enforceable by Adobe in addition to Electronics For Imaging.

**General**

This Agreement will be governed by the laws of the State of California.

This Agreement is the entire agreement held between us and supersedes any other communications or advertising with respect to the Software, Coded Font Programs and accompanying documentation.

If any provision of this Agreement is held invalid, the remainder of this Agreement shall continue in full force and effect.

If you have any questions concerning this Agreement, please write to Electronics For Imaging, Attn: Licensing Dept. or see Electronics For Imaging's web site at [www.efi.com](http://www.efi.com).

Electronics For Imaging  
303 Velocity Way  
Foster City, CA 94404

## Introduction

### Introduction

This document describes how to install a second CPU and an AGP video board in the Print Server.

**NOTE:** If you are going to install system software after completing the Dual CPU update, first make sure an AGP video board is installed in the Print Server. The system will hang during system software installation if no AGP video board is present in the Print Server.

Along with this document, this kit includes:

- CPU with cooling assembly
- AGP video board
- Dual CPU update dongle (can only be used once)
- Restore/Update Server Software CD

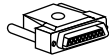

**NOTE:** Both the Dual CPU kit and the FACI kit include an AGP video board. If the Print Server you are servicing uses both kits, place the extra AGP video board in an anti-static bag and save it for future use.

### Procedures

To use this kit, perform the following procedures:

- Insert the CD into the CD-ROM drive on the Print Server
- Shut down the Print Server
- Remove the side panel
- Install the CPU in socket J51 on the motherboard
- Install the AGP video board in the AGP connector (Slot 1) on the motherboard
- Reassemble the Print Server
- Enable the dual CPU option using the dongle and CD

Before shutting down the Print Server, make sure to install the Restore/Update Server Software CD in the Print Server's CD-ROM drive. Always use the procedure below when shutting down the Print Server.

---

TO INSTALL THE RESTORE/UPDATE SERVER SOFTWARE CD AND SHUT  
DOWN THE PRINT SERVER



Always verify that the Print Server is not in use before you power off or restart it. Make sure that the system is not ripping or printing a job.

1. Make sure the Info screen reads Idle.  
When Printing or Ripping appears on the Control Panel, the system is currently processing. Idle appears in the Info screen when the system is finished processing the job.
2. Install the Restore/Update Server Software CD in the Print Server's CD-ROM drive.
3. At the Idle screen, press the menu button once to display the Functions menu.
4. Select Shut Down from the Functions menu.
5. At the next screen, select Shut Down System.  
The message It is now safe to power off the system.... is displayed.
6. Power off the system using the power switch on the back panel (press 0).
7. Disconnect all cables from the back panel of the Print Server.



## Procedures

---

### TO OPEN THE PRINT SERVER

1. Make sure you have powered off the Print Server and removed all the cables from the back.
2. Remove the two screws that secure the side panel to the chassis.
3. Lift off the side panel (see below).

Press on the front edge of the side panel as you slide the panel off the chassis.

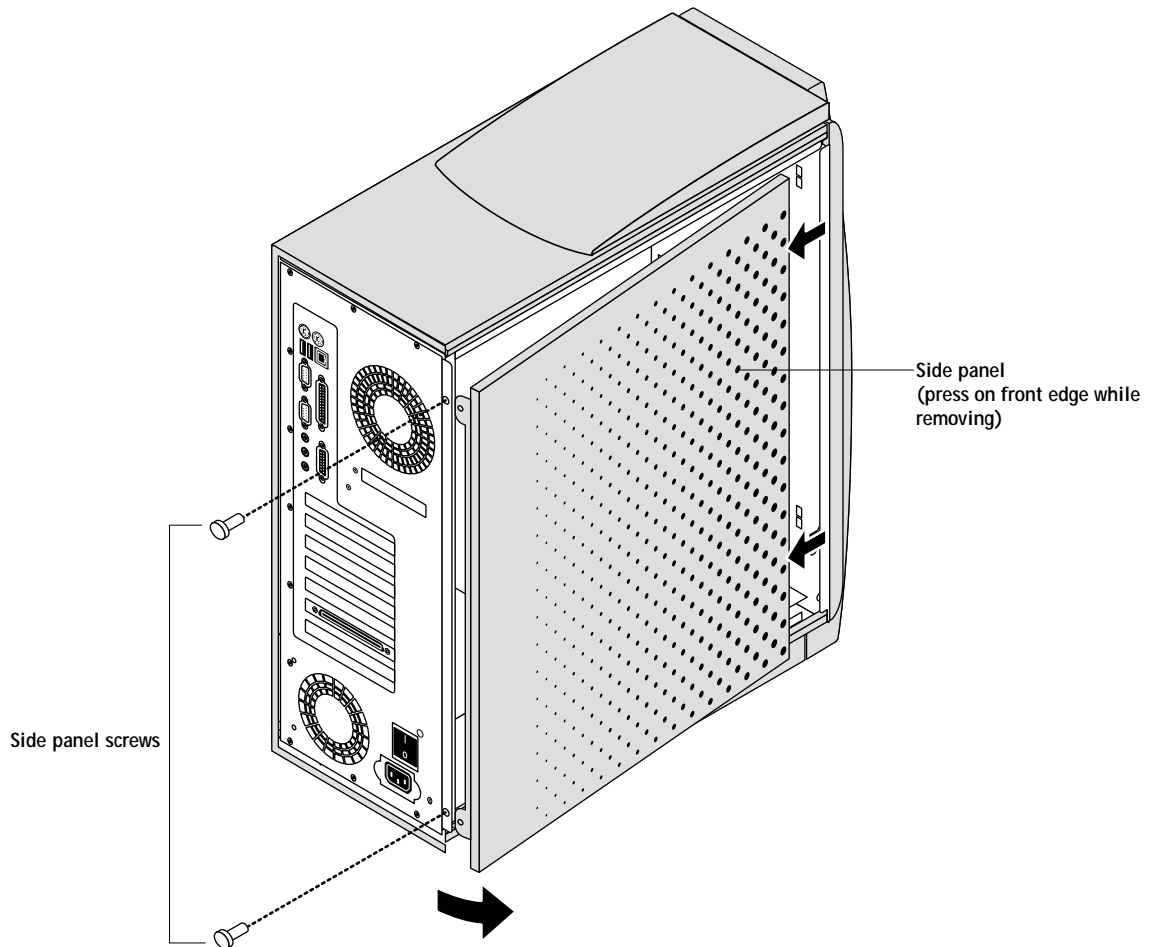

The CPU socket and the AGP connector on the motherboard are now accessible. Attach an ESD wrist strap before handling internal parts.

## Using the Dual CPU Kit

---

### TO INSTALL THE CPU IN THE PRINT SERVER

1. Unpack the CPU and cooling assembly.
2. Wipe the contact surface of the CPU with a clean, lint-free cloth to assure good contact with the heatsink.
3. Insert the CPU into socket J51.

Make sure you align the arrow indicating pin 1 on the CPU with pin 1 in the CPU socket (see the figure below).

4. Lower the socket lever to secure the CPU.

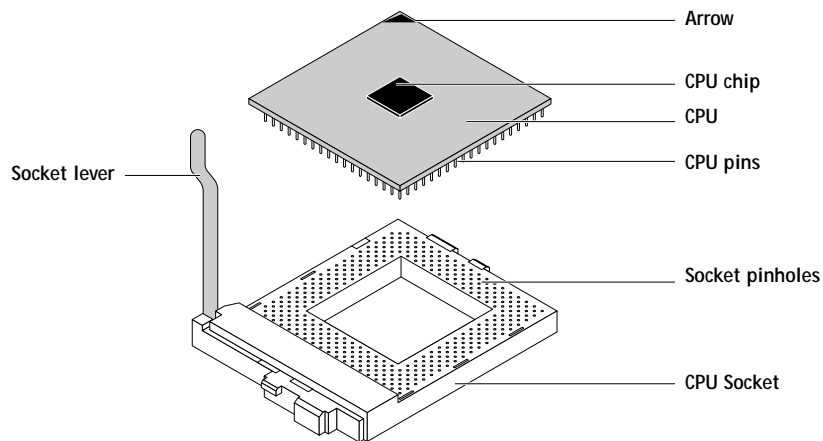

5. At the base of the heatsink remove the protective covering over the thermal compound. Make sure there are no air bubbles or wrinkles in the thermal compound. Bubbles and wrinkles reduce the heat-transfer efficiency of the cooling assembly.
6. Install the CPU cooling assembly on top of the CPU (see Table A).



**NOTE:** The CPU cooling assemblies shipped with the CPU may differ. To identify the CPU cooling assembly shipped with the CPU you are installing, see the following table and follow the appropriate procedure.

Make sure the thermal compound on the base of the heatsink completely covers the CPU chip. Incorrect installation could cause the CPU to overheat.

## Procedures

TABLE A Installing CPU Cooling Assemblies

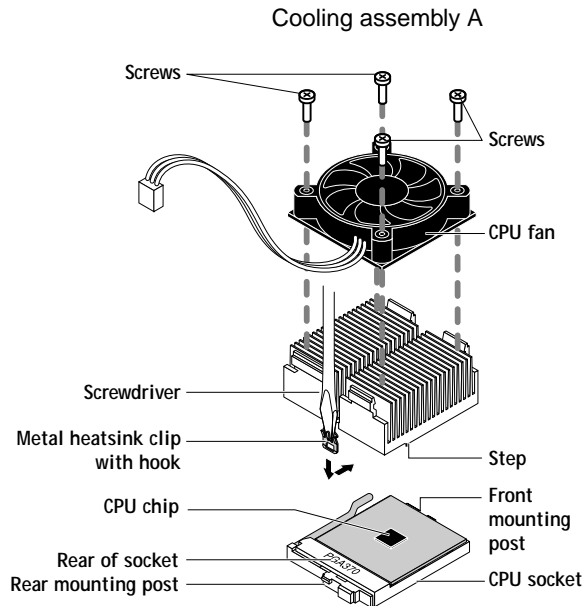

- Align the step on the bottom of the heatsink with the rear of the CPU socket.
- Place the heatsink on the CPU so that the thermal compound on the heatsink step completely covers the CPU chip.
- Secure the non-hook end of the heatsink clip over the front mounting post on the CPU socket.
- Insert a flathead screwdriver into the hook on the heatsink clip and carefully press down to secure the clip over the rear mounting post on the CPU socket.

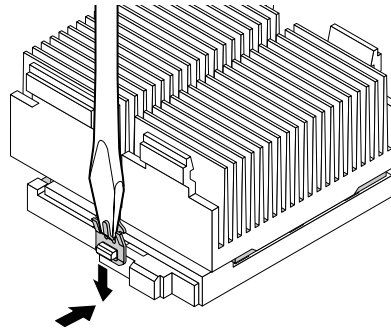

Be careful not to damage the motherboard, the CPU, or the CPU socket when using a screwdriver on the Print Server.

- Place the CPU fan on top of the heatsink and secure it with screws as shown.

## Using the Dual CPU Kit

TABLE A Installing CPU Cooling Assemblies (Continued)

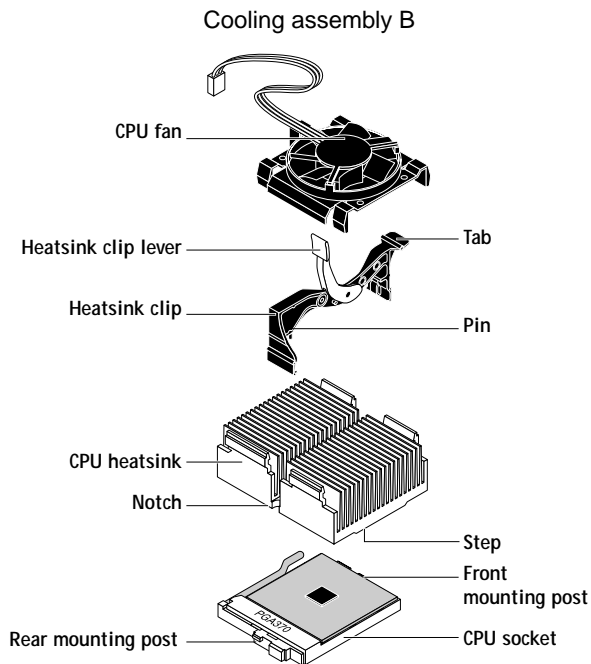

- Align the notch on the bottom of the heatsink so that it is directly over the rear mounting post on the CPU socket.
- Place the heatsink on the CPU so that the thermal compound on the heatsink step completely covers the CPU chip.
- Align the pin on the plastic heatsink clip with the notch on the bottom of the heatsink.
- First secure the clip over the rear mounting post on the CPU socket, then secure the clip over the front mounting post by pressing down on the tab until the clip snaps into place.
- Lower the heatsink clip lever.
- Place the CPU fan on top of the heatsink and snap it into place.

## Procedures

TABLE A Installing CPU Cooling Assemblies (Continued)

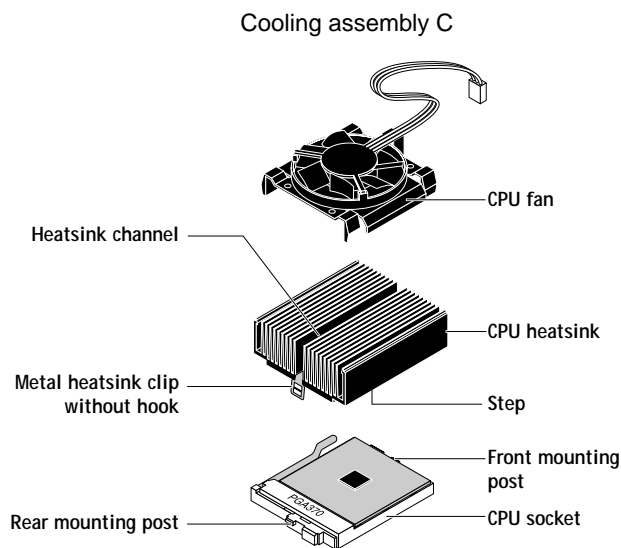

- Align the step on the bottom of the heatsink with the rear of the CPU socket.
- Place the heatsink on the CPU so that the thermal compound on the heatsink step completely covers the CPU chip.
- Secure the heatsink clip to the front mounting post on the CPU socket.

NOTE: One end of the clip has a single slot and the other end has two slots. The single slot end goes over the front mounting post.

- Insert the flat end of a plastic pen or other non-slippery tool into the heatsink channel and press down on the clip to relieve the clip's tension.

NOTE: To best relieve tension on the clip, press down on the clip toward the end nearest the rear mounting post.

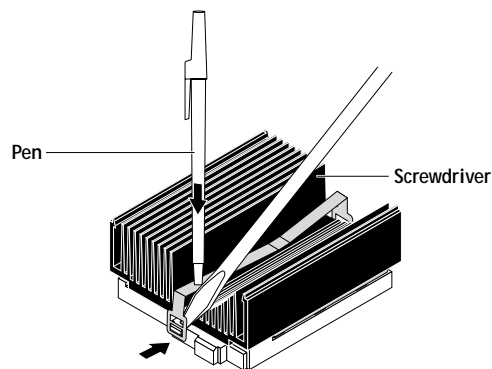

- While continuing to relieve tension on the clip, use a flathead screwdriver to hook the heatsink clip over the rear mounting post on the CPU socket.

Be careful not to damage the motherboard, the CPU, or the CPU socket when installing the heatsink clip.

- Place the CPU fan on top of the heatsink and snap it into place.

### 7. Connect the CPU fan cable to the motherboard connector FAN5.

Secure the CPU fan cable using a tie-wrap. The tie-wrap will prevent the fan cable from interfering with the CPU fan. Also, make sure the connector on the CPU fan cable is securely connected to the motherboard.

### 8. Reassemble the Print Server.

## Using the Dual CPU Kit

### TO INSTALL THE AGP VIDEO BOARD IN THE PRINT SERVER

1. Unpack the AGP video board.
2. Remove the cover plate from Slot 1 on the back panel of the Print Server.  
Set aside the cover plate mounting screw for use later in this procedure.
3. Position the AGP video board so that the component side of the board faces down toward the power supply.

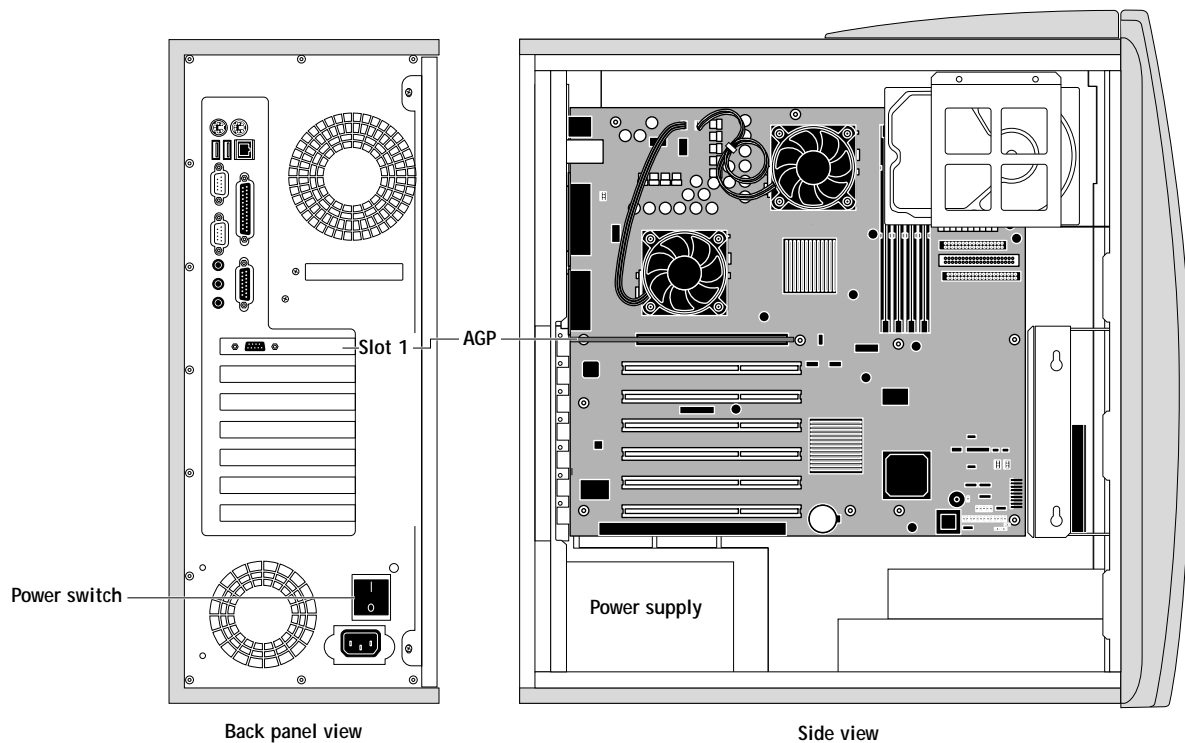

**NOTE:** The Print Server you are servicing may include an additional CPU and other boards not shown above.

4. Insert the edge connector of the AGP video board into the AGP connector on the motherboard (Slot 1).  
The board's edge connector is keyed to fit only one way when properly oriented.
5. Use the mounting screw removed earlier to secure the AGP video board in Slot 1 on the back panel.

---

TO REASSEMBLE THE PRINT SERVER

1. Place the side panel into the grooves along the edge of the chassis (see below).  
Be careful not to damage any ribbon cables; fold the ribbon cables inside the chassis before replacing the side panel. Press on the front edge of the side panel during installation in order to compress the EMI gaskets around the edges of the chassis.

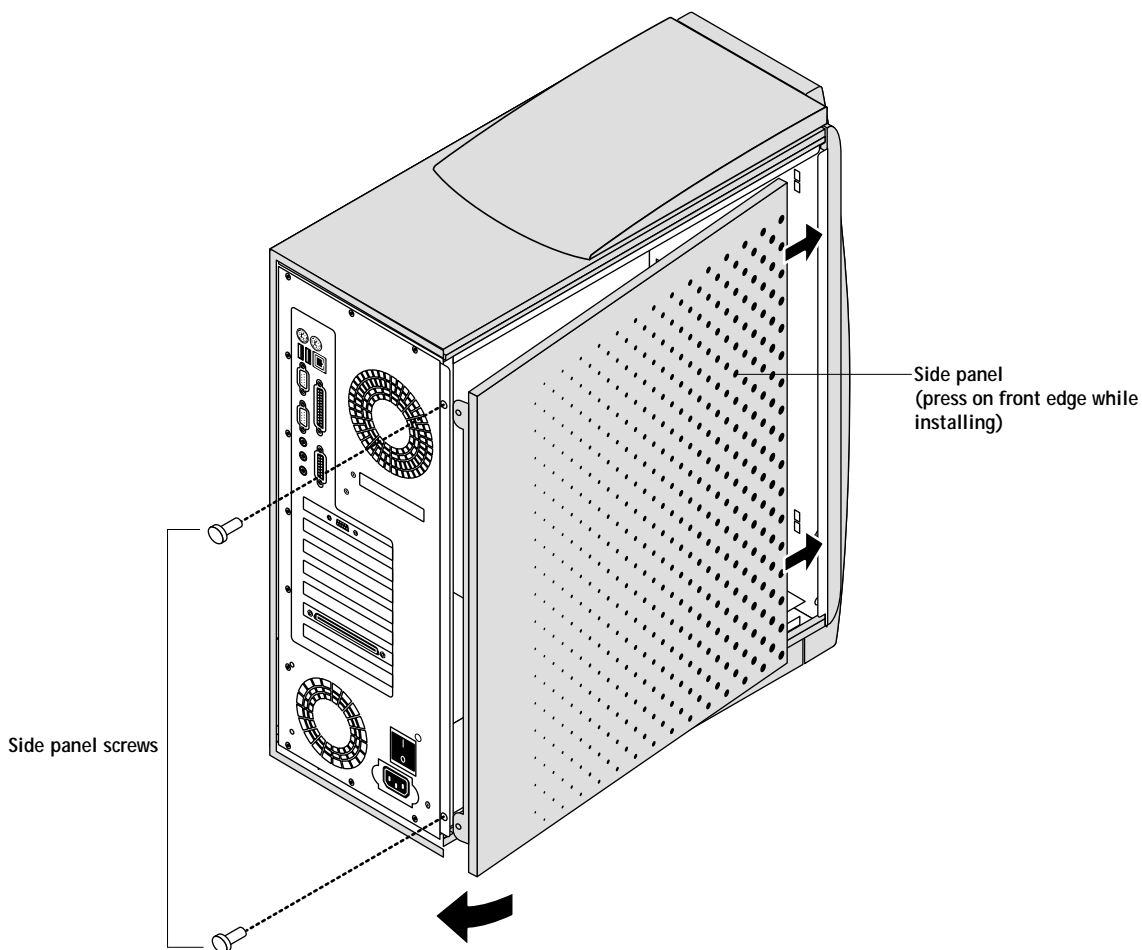

2. Replace the two screws that secure the side panel to the cover.  
**NOTE:** Do not leave the Print Server cover off after servicing. An airflow channel is created by the cover and the fan. Leaving the Print Server cover off for extended periods of time could reduce the operational life expectancy of internal Print Server components.
3. Connect any cables you removed during service to the back of the Print Server.
4. Enable the dual CPU option (see the following procedure).

## Using the Dual CPU Kit

---

### TO ENABLE THE DUAL CPU OPTION

**NOTE:** This procedure assumes that the Print Server is powered off and the Restore/Update Server Software CD is installed in the Print Server's CD-ROM drive.

The dongle and the Restore/Update Server Software CD are used together to enable the second CPU on the Print Server.

1. Connect the dongle to the parallel port as shown in the following illustration.

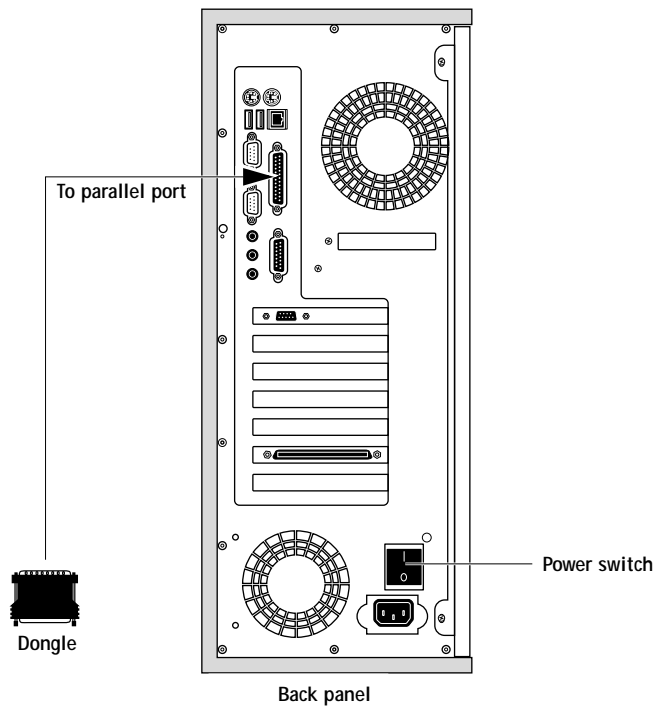

2. Make sure all the cables are connected to the back panel.
3. Power on the Print Server.



## Procedures

- When the Restore/Update menu appears, scroll to display "Update system", select OK, then wait.

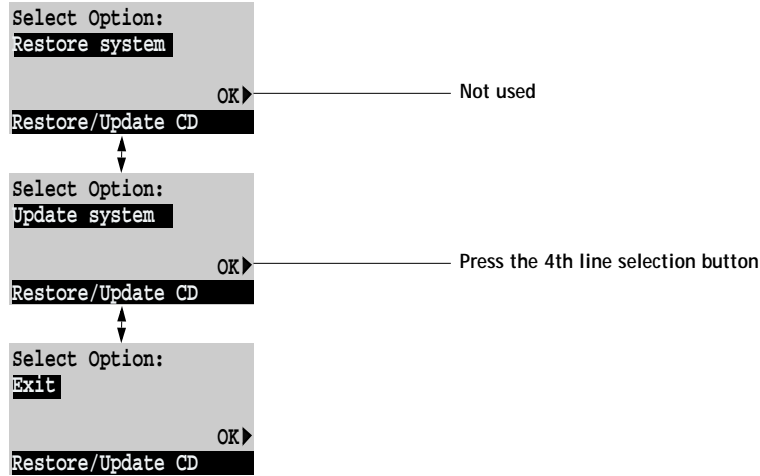

- At the message "Update complete" select OK.
- Scroll to display the "Exit" menu and select OK.
- At the message "Remove CD and recycle power", remove the CD and power off the Print Server using the power switch on the back panel (press 0).
- Remove the dongle and mark it used.
- Power on the system using the power switch on the back panel and allow the system to reach Idle.

NOTE: If you are going to install system software after completing the Dual CPU update, first make sure an AGP video board is installed in the Print Server. The system will hang during system software installation if no AGP video board is present in the Print Server. See the next section if an error message is displayed.

### Error messages

The following error messages may appear on the Control Panel LCD if a required system update is not done.

Wrong/Missing . . . dongle—the system was not updated. Install the correct dongle and repeat the system update procedure.

Used Dongle—the dongle has already been used to upgrade a system and cannot be used again. Install a new dongle and repeat the system update procedure.